



Electrochemical 3-Electrode Sensor

EC4-NH₃-100-01 Ammonia Gas Sensor
Datasheet

Easy Gas Sensor









EC4-NH₃-100 Ammonia Gas



» Part Number

01-EC4-NH₃-100-01

» Features

-  Detects with high selectivity a wide variety of gases
-  Double sealed housing for advanced leakage protection
-  Stable zero
-  Linear output
-  High sensitivity
-  nA power consumption
-  Wide operation temperature range of -30°C to +55°C
-  Typical warm-up time in minutes
-  RoHS compliant

» Typical Applications

-  Industrial Safety
-  Leakage Detection
-  Emission Monitoring
-  Sewage/Water Treatment Plant
-  Biogas
-  Garbage Disposal
-  Semiconductor Industry
-  Warehouse Logistics Monitoring
-  Livestock Farming
-  Indoor Air Quality



» Technical Specifications

Performance

Sensitivity	115 nA/ppm ± 35 nA/ppm
Zero Current	± 300nA
Range	0-100ppm
Maximum Overload	200ppm
Resolution (16Bit ADC)	0.1 ppm
Response Time	T ₅₀ < 20s, T ₉₀ < 50s
Repeatability	2%
Linearity	Linear

Environment

Operating Temperature Range	-30 to +55°C
Operating Humidity Range	15-95 %RH. Non-condensing
Operating Pressure Range	800 to 1200 hPa
Storage Temperature	0 to 20°C (Optimum temp. 4 to 6°C)

Operation

Operating Principle	Amperometric
Bias Voltage	0 mV
Recommended Load Resistor	100 Ω
Warm-Up Time	< 60 s

Lifetime

Long-Term Drift	< 1 %/month
Expected Lifetime	> 2 years
Zero Drift in Clean Air	< 1 ppm
Storage Life	6 months
Warranty	12 months

***Note:** Long-Term Drift may vary depending on storage conditions and usage.

Housing

Housing Material	ABS
Weight	< 8g

» Dimensions

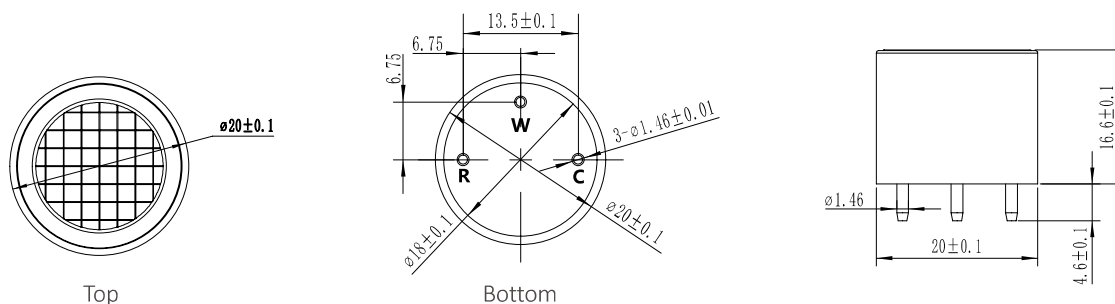

» Cross Sensitivity

Gas	Formula	Test Concentration	Sensor Reading
Benzene	C ₆ H ₆	1 ppm	0 ppm
Methane	CH ₄	1 %	0 ppm
Carbon Dioxide	CO ₂	10 %	0 ppm
Trimethylamine	/	1 ppm	PRE*

*Positive Reading Expected

Note:

- 1) The above interference factors may vary due to different sensors and service life, please refer to the actual test results.
- 2) This table is not complete for all cross gases. Please contact us for other gases.
- 3) The above parameters are the test results at a temperature of 25°C, a relative humidity of 50%RH and a normal pressure environment. The performance of the sensor varies under different environmental conditions. If you have any questions, please contact us.
- 4) The above cross interferences are represented by a low concentration of the gas.

» Temperature Curve

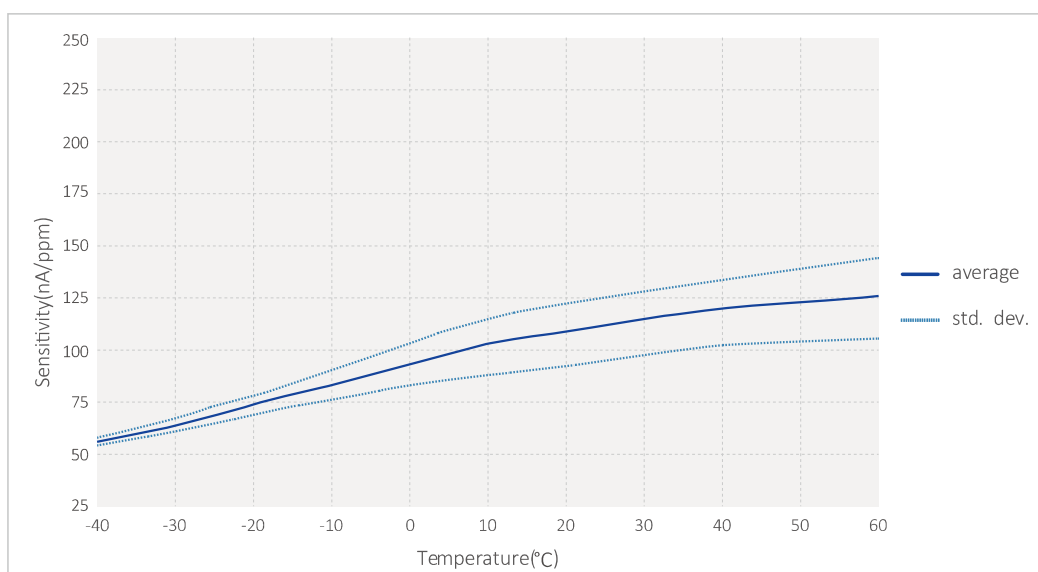

Disclaimer

The EC Sense performance data stated above is based on data obtained under test conditions using the EC Sense gas distribution system and AQS test software. In the interest of continuous product improvement, EC Sense reserves the right to change design features and specifications without notice. We are not responsible for any loss, injury or damage caused by this. EC Sense assumes no responsibility for any indirect loss, injury or damage resulting from the use of this document, the information contained therein or any omissions or errors herein. This document does not constitute an offer to sell. The data it contains are for informational purposes only and cannot be considered a guarantee. Any use of the given data must be evaluated and determined by the user to comply with federal, state and local laws and regulations. All specifications outlined are subject to change without notice.

Warning

EC Sense sensors are designed for use in a variety of environmental conditions. However, due to the principles and characteristics of electrochemical sensors and to ensure normal use, users must strictly follow this article during storage, assembly and operation of the module. Avoid cleaning the sensors with alcohol, acetone or other strong solvents. General-purpose PCB circuit board application methods and illegal applications / violation of the application will not be covered by the warranty. Although our products are highly reliable, we recommend checking the module's response to the target gas prior to utilization to ensure on-site use. At the end of the product's service life, please do not discard any electronics in the domestic waste, instead follow the local governments electronic waste recycling regulations for disposal.